

**Slotted Optical Switch**  
**OPB854A1, OPB854A2, OPB854A3**  
**OPB854B1, OPB854B2, OPB854B3**

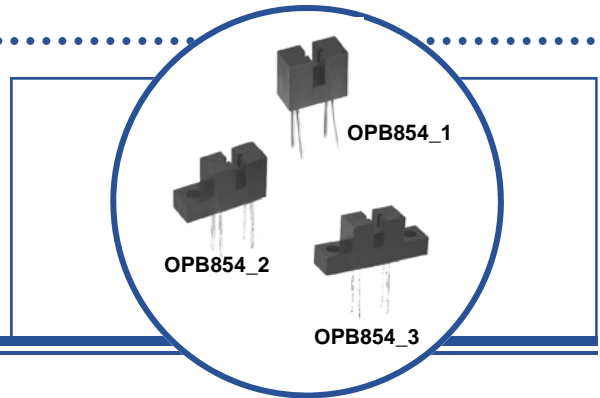

**Features:**

- Opaque housing material for ambient light rejection
- Non-contact switching
- Printed circuit board mounting, lead spacing 0.300" (7.62 mm)
- Slot width 0.100" (2.54 mm)
- Choice of three mounting configurations



**Description:**

Each **OPB854** series contains an Infrared Light Emitting Diode (LED) and an NPN silicon phototransistor mounted on opposite sides of a 0.100" (2.54 mm) wide slot in an opaque plastic housing. The OPB854 series has an equivalent aperture of 0.60" (1.52 mm) in diameter because of the lens on the emitting and sensing devices.

The difference between the **OPB854A** series and **OPB854B** series are electrical characteristics.

Switching of the phototransistor occurs whenever an opaque object passes through the slot.

Custom electrical, wire and cabling and connectors are available. Contact your local representative or OPTEK for more information.

**Applications:**

- Non-contact interruptive object sensing
- Assembly line automation
- Machine automation
- Equipment security
- Machine safety

Ordering Information					
Part Number	LED Peak Wavelength	Sensor	Slot Width / Depth	Aperture Emitter/Sensor	Lead Length / Spacing
OPB854A1	890 nm	Transistor	0.100" / 0.250"	None	0.400" / 0.300"
OPB854B1					
OPB854A2					
OPB854B2					
OPB854A3					
OPB854B3					



**RoHS**

OPTEK reserves the right to make changes at any time in order to improve design and to supply the best product possible.

**Slotted Optical Switch**  
**OPB854A1, OPB854A2, OPB854A3**  
**OPB854B1, OPB854B2, OPB854B3**

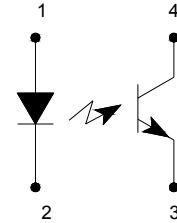
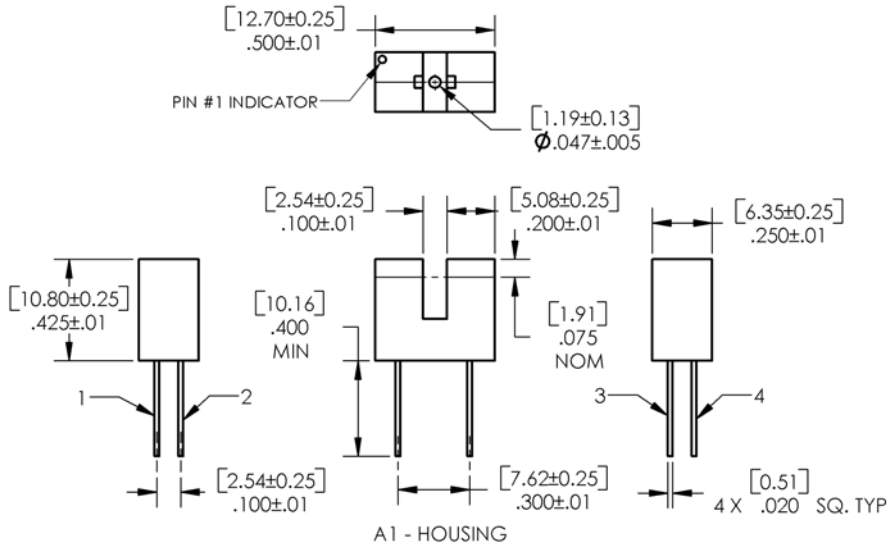

Pin #	Description
1	Anode
2	Cathode
3	Emitter
4	Collector

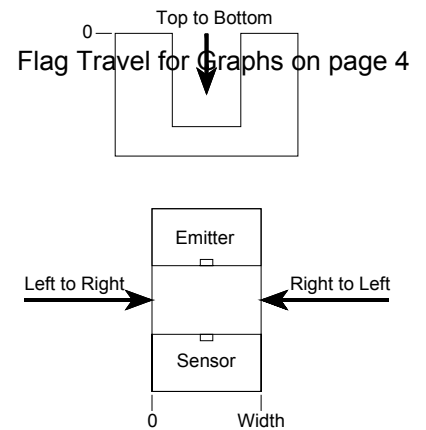
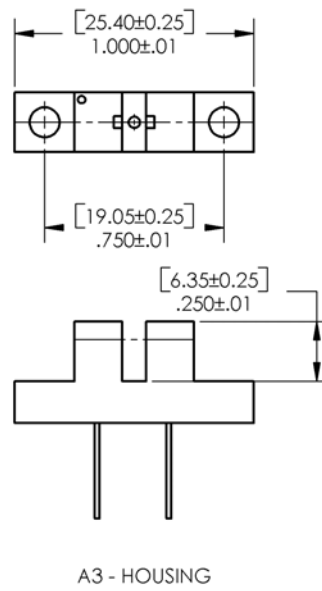
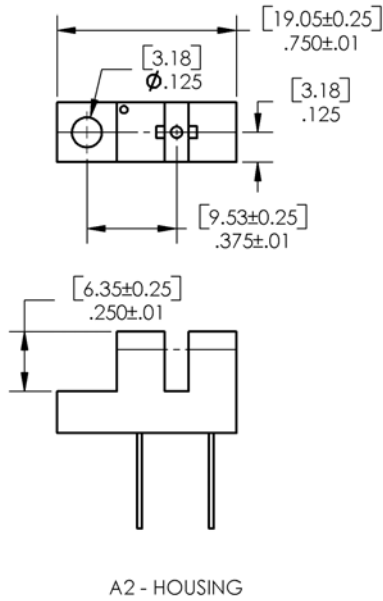

[ MILLIMETERS]  
 DIMENSIONS ARE IN: INCHES

OPTEK reserves the right to make changes at any time in order to improve design and to supply the best product possible.

**Slotted Optical Switch**  
**OPB854A1, OPB854A2, OPB854A3**  
**OPB854B1, OPB854B2, OPB854B3**



**Absolute Maximum Ratings** ( $T_A=25^{\circ}\text{C}$  unless otherwise noted)

Storage & Operating Temperature Range	-40° C to +85° C
Lead Soldering Temperature [1/16 inch (1.6mm) from the case for 5 sec. with soldering iron] <sup>(1)</sup>	260° C

**Input Diode**

Forward DC Current	50 mA
Peak Forward Current (1 $\mu\text{s}$ pulse width, 300 pps)	3 A
Reverse DC Voltage	2 V
Power Dissipation <sup>(2)</sup>	100 mW

**Output Phototransistor**

Collector-Emitter Voltage	30 V
Emitter-Collector Voltage	5 V
Collector DC Current	30 mA
Power Dissipation <sup>(2)</sup>	100 mW

**Electrical Characteristics** ( $T_A = 25^{\circ}\text{C}$  unless otherwise noted)

SYMBOL	PARAMETER	MIN	TYP	MAX	UNITS	TEST CONDITIONS
--------	-----------	-----	-----	-----	-------	-----------------

**Input Diode** (see OP140 for additional information)

$V_F$	Forward Voltage	-	-	1.7	V	$I_F = 20 \text{ mA}$
$I_R$	Reverse Current	-	-	10	$\mu\text{A}$	$V_R = 2 \text{ V}$

**Output Phototransistor** (see OP550 for additional information)

$V_{(BR)CEO}$	Collector-Emitter Breakdown Voltage	30	-	-	V	$I_C = 1 \text{ mA}$
$V_{(BR)ECO}$	Emitter-Collector Breakdown Voltage	5	-	-	V	$I_E = 100 \mu\text{A}$
$I_{CEO}$	Collector Dark Current	-	-	100	nA	$V_{CE} = 10 \text{ V}, I_F = 0, E_E = 0$

**Combined**

$V_{CE(SAT)}$	Collector-Emitter Saturation Voltage OPB854A series OPB854B series	- -	- -	0.6 0.4	V	$I_C = 2 \text{ mA}, I_F = 16 \text{ mA}$ $I_C = 250 \mu\text{A}, I_F = 20 \text{ mA}$
$I_{C(ON)}$	On-State Collector Current OPB854A series OPB854B series	3 1	- -	- -	mA	$V_{CE} = 1 \text{ V}, I_F = 16 \text{ mA}$ $V_{CE} = 10 \text{ V}, I_F = 20 \text{ mA}$

Notes:

- (1) RMA flux is recommended. Duration can be extended to 10 seconds maximum when flow soldering.
- (2) Derate linearly 1.67 mW/°C above 25 ° C.
- (3) All parameters tested using pulse techniques.
- (4) Lead spacing of 0.220" (5.59 mm) or 0.320" (8.13 mm) is available. Leads are 0.20" sq. (5.1 mm) and 0.425" (10.8 mm) long (minimum).
- (5) Methanol or isopropanol are recommended as cleaning agents. Plastic housing is soluble in chlorinated hydrocarbons and ketones.
- (6) Polarity is denoted by color of housing top (gray or clear LED, black sensor).

OPTEK reserves the right to make changes at any time in order to improve design and to supply the best product possible.

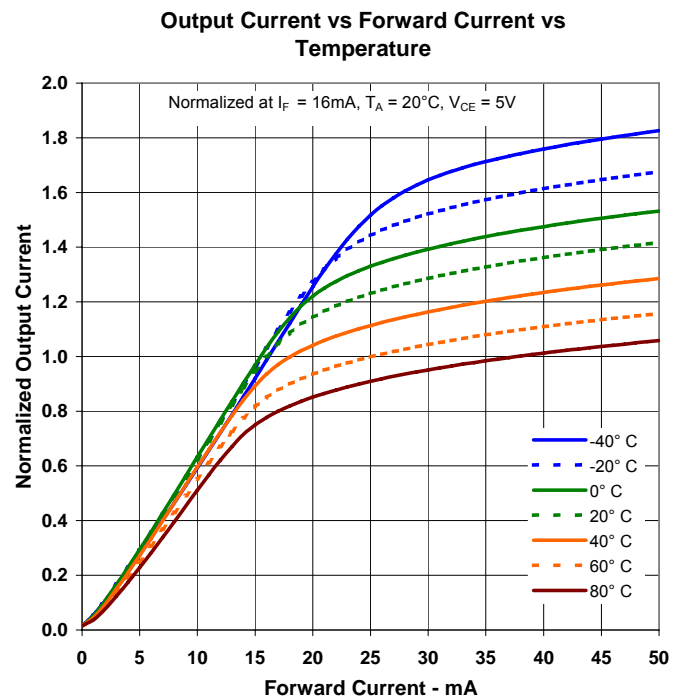
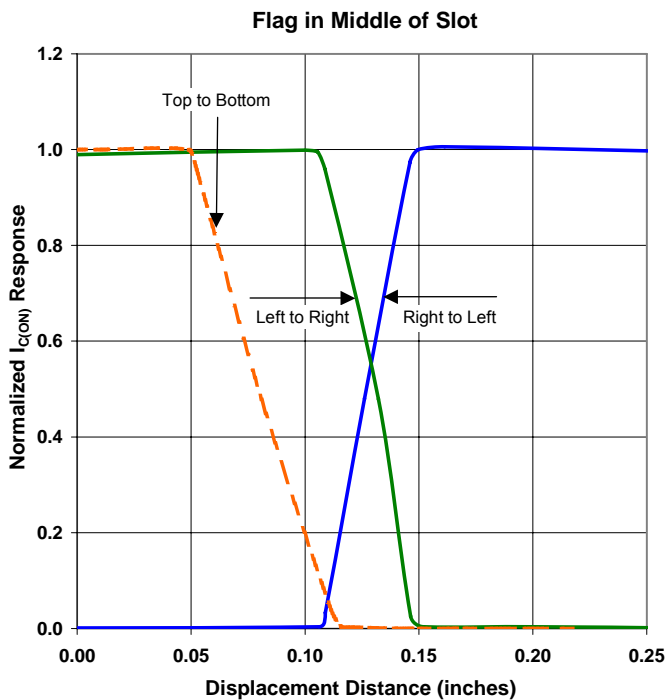
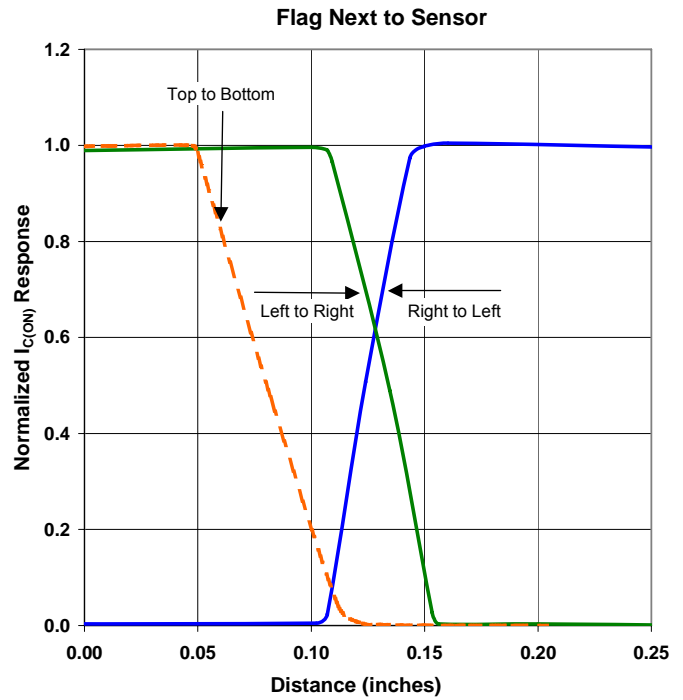
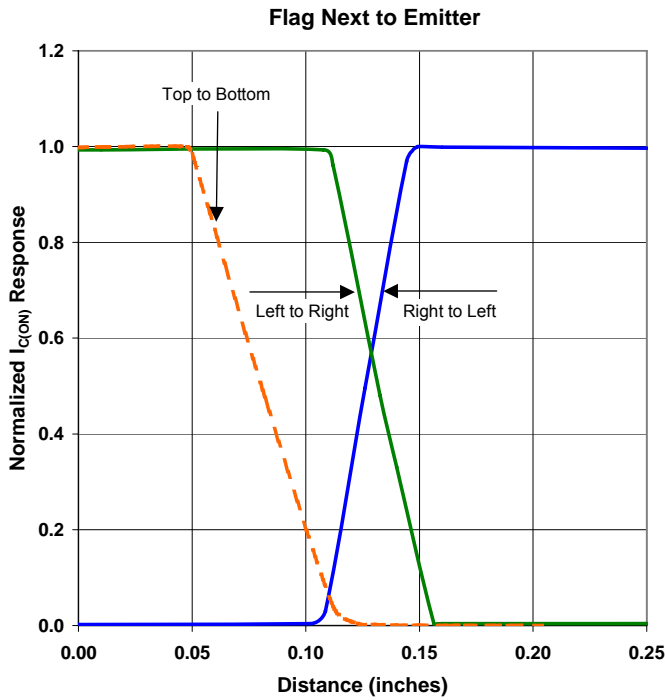

OPTEK reserves the right to make changes at any time in order to improve design and to supply the best product possible.